

A few simple steps to ensure
perfect water, every time.



We're Here to Help



We are also available
for live video chat!

Email Us:

support@avalonh2o.com
sales@avalonh2o.com

Availability:

Monday-Friday: 9 a.m.-5 p.m.

Let's Connect

Follow our social media accounts and stay up to
date on the latest Avalon news.



@avalon_h2o



Avalon Water Coolers



Avalonh2o

www.avalonh2o.com

Use and Care Guide

MODEL: A-ICE2

Registration

Please visit the website below to register your new water cooler within the first 30 days of purchase. Registration within the first 30 days will activate your one year warranty.

www.avalonh2o.com/register-my-avalon-cooler

Please keep your model number, order number and purchase date for future support. You can reach us at support@avalonh2o.com.

Model Number _____

Order Number _____

Purchase Date _____

Contents

About Your Product

Meet Your Avalon Product	6-7
Warnings before use	8-9
Technical Parameters & Electric Principle Diagram	10-11
Preparation For Use	12
Models & Function	13-14

Getting Started

Opening The Ice Storage Drawer	16
Removing The Ice Storage Drawer	17
Installing The Drip Tray	18

Installation

Installation (under the sink)	20-21
Installation (refrigerator water line)	22
Finishing the Ice Maker Installation	23-24
Making Ice	25-26
Nightlight	27

Cleaning

Maintenance	29
Cleaning	30-32

Troubleshooting

Warranty	34-35
----------	-------

Meet Your Avalon Product

Inside the box, you'll find:

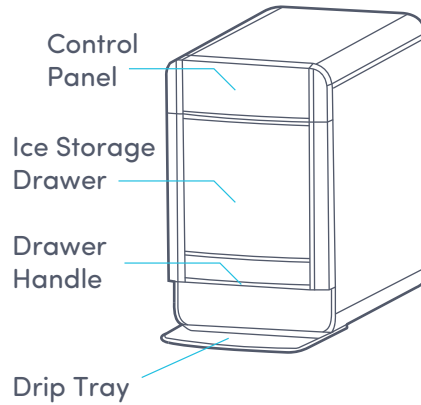

Carbon Block Filter



Sediment Filter

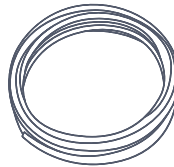

PE Tubing



3 Way Plastic Adapter



Ice Shovel

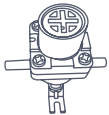

Pressure Regulator

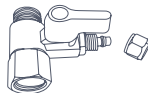

Metal Adapter With Valve

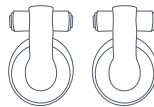

2 Filter Adapters

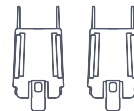

2 Mounting Brackets



2 Small PE Tubing

Meet Your Avalon Product



Attractive Design
Elegant design with
brushed stainless
steel surface



Self-Cleaning
Worry-Free
Self-Cleaning
Technology



Dual Filtration
Inbuilt water filter to
reduce lead, large
particles, chlorine, taste
and odor in water



**5.5 lb storage
capacity**
Large maximum
capacity



**Large quantity
of ice**
38 lb of ice
per day

Warnings before use

After unpacking the machine, it needs to stand at least 24 hours before powered on.

Do not damage the power cord or plug. Avoid heating, twisting or pulling power cord. These actions may result in electric short circuit and/or fire.

Use the correct power socket, the power socket must have reliable grounding, and ensure that the power plug is fully inserted into the socket. Due to the safety hazard in some conditions, we strongly recommend not to use an extension cord, if you must use it, please use a 3-wire grounded cord with a rated current (minimum) 15A.

Do not squeeze or pull the power cord. The power cord should be placed in a place where it will not be disturbed and should not be immersed in water. Keep this product away from children or inexperienced unless they are supervised or prompted by those knowledgeable and responsible for their safety.

Do not use wet hands to plug and unplug the power supply, otherwise it may cause electric shock, burn or other injuries.

This product must be installed and used correctly, please read this manual carefully before installation.

This product is only suitable for indoor use, do not use it outdoors.

Do not store or use flammable gas or liquid near the machine.

Do not store explosives (such as gasoline, accelerant, etc.) in the machine.

Do not allow children to climb, stand or hang from the ice maker.

The machine can only be filled with potable water.

Please cut off the power before manual cleaning, repair or maintenance.

Do not clean the ice maker with flammable or caustic liquids. This may cause fire or explosion.

Warnings before use

Do not remove any safety, warning or product information identification information from the product.

It is recommended that 2 people carry and install the ice maker to avoid injury.

After the ice maker is disconnected from the power supply, please remove all the ice from the drawer to prevent the ice cubes from overflowing the machine.

Dispose of the device in accordance with federal and local regulations. The flammable refrigerants and thermal insulation materials used require special handling procedures, please contact your local authorities for safe and environmentally friendly disposal of your appliances.

Warning: Flammable refrigerants present a fire or explosion hazard.

The refrigerant used in the refrigerator is flammable, please follow the safety warnings below to reduce the risk of injury or financial loss. See below:

Do not damage the refrigeration pipeline during transportation, installation and operation.

When maintenance service is required, please contact the manufacturer or a professional and qualified technician.

A space of more than 150mm should be reserved around the ice maker to ensure good ventilation.

To defrost, use a plastic or wooden scraper. Do not remove mechanical devices or electrical appliances frost, as it can puncture the liner and damage the refrigeration lines.

Do not use electrical appliances in the water tank/ice basket/ice storage drawer of the ice maker.

Dispose of the device in accordance with federal and local regulations. The flammable refrigerants and thermal insulation materials used require special handling procedures, please contact your local authorities for safe and environmentally friendly disposal of your appliances.

Technical Parameters & Electrical Wire Diagram

Product Name	Nugget ice maker
Product Model	A-ICE
Rated Voltage	115V
Rated frequency	60Hz
Ice making capacity/24hr	38lb
Ice storage capacity	5.5lb
Climate type	SN N ST
Current	2.8A
Refrigerant/g	R600a/31g
Product size (in)	10.23*16.73*16.73
Package size (in)	12.4*18.5*20.5

Technical Parameters & Electrical Wire Diagram

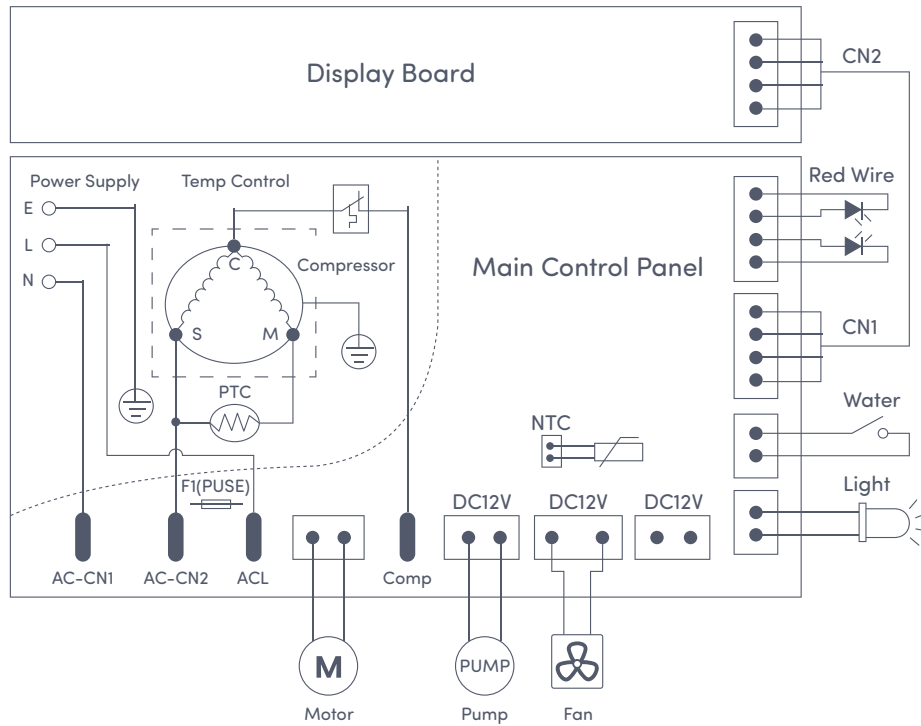

Preparation for use

Attention: For optimal use of the product, please abide by the following information.

1. The ice maker is designed for indoor use, do not use it outdoors.
2. The ice maker should be placed away from direct sunlight and heat sources.
3. A space of more than 150mm should be reserved around the ice maker to ensure good ventilation.
4. The location where the ice maker is placed has a suitable socket that meets
5. The location where the ice maker is placed has a suitable socket that meets the safety requirements.
6. Remove the packaging carefully, do not use sharp tools, which may damage the internal accessories or products.
7. Place the ice maker upright on a stable horizontal surface that can support the weight of the ice maker with water and ice.
8. Open the drawer and take out the instruction manual and ice shovel placed inside.
9. Place the drip tray on the bottom of the front of the ice maker, and push it to the front foot.
10. Thoroughly clean the ice maker with clean water.

Models And Functions

Model	Ice maker
H-ICE2	1

Indicator Panel



Control Panel

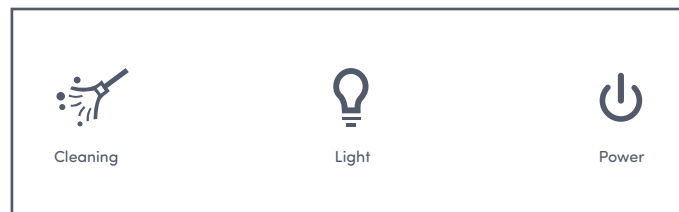

Functions

After plugging in the power plug and connecting to the power supply, the unit will turn on with the power indicator illuminated. The ice making indicator will also turn on and the unit will begin making ice. The nightlight will also turn on automatically. In order to turn off the ice making, touch the power button. The power indicator as well as the ice making indicator will turn off.



To start the self cleaning function, press and hold the cleaning button for 3 seconds and the cleaning indicator will illuminate. This cleaning cycle will run for 5 minutes.

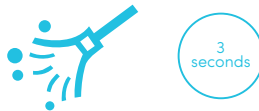

To turn off the nightlight, press the nightlight button. To turn the nightlight back on, press the night light button again.



Please note: The ice making mode and cleaning mode cannot be used at the same time.

Getting Started

Opening the Ice Storage Drawer

When opening the ice storage drawer, hold the handle at the bottom of the drawer. Pull the drawer outward in a horizontal direction gently until the lower edge of the drawer hooks the left and right limit posts of the inner tank. Allow the drawer to rest while it hangs on the machine at an inclined angle.

When closing the drawer, hold the handle, straighten the drawer upwards, and then gently push it until it is completely closed.

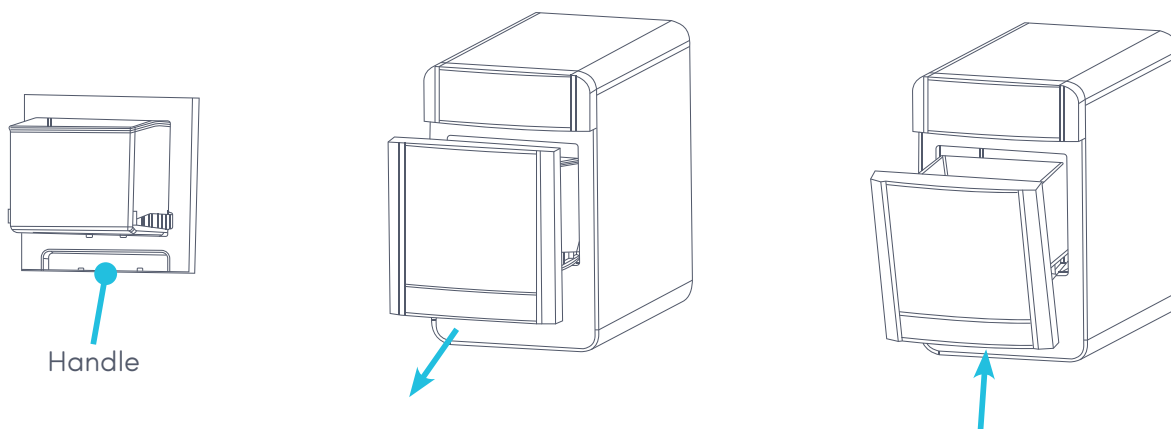

Removing the Ice Storage Drawer

When removing the ice storage drawer, hold the handle at the bottom of the drawer. Pull the drawer outward in a horizontal direction gently until the lower edge of the drawer hooks the left and right limit posts of the inner tank. Lift it up to an inclined angle, and then pull the drawer outward to remove it.

When you need to re-install the drawer, first lift the drawer up to an inclined angle, then put the raised hooks on the back of the drawer into the left and right limit posts of the inner tank. Gently push the drawer until the drawer is completely closed.

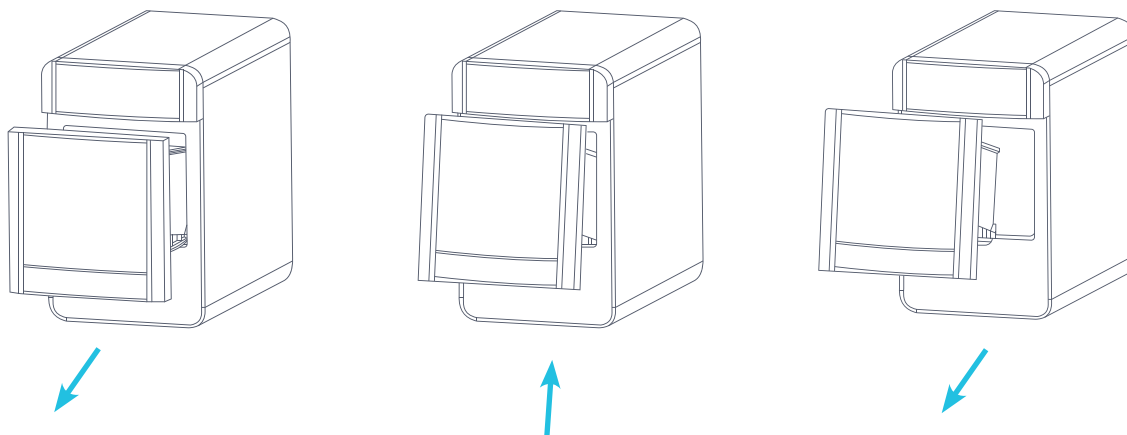

Installing the Drip Tray

When installing the drip tray, place the drip tray on the table or countertop and push it vertically into the bottom of the front of the ice maker. To remove the drip tray, simply pull the drip tray vertically out of the bottom of the ice maker.

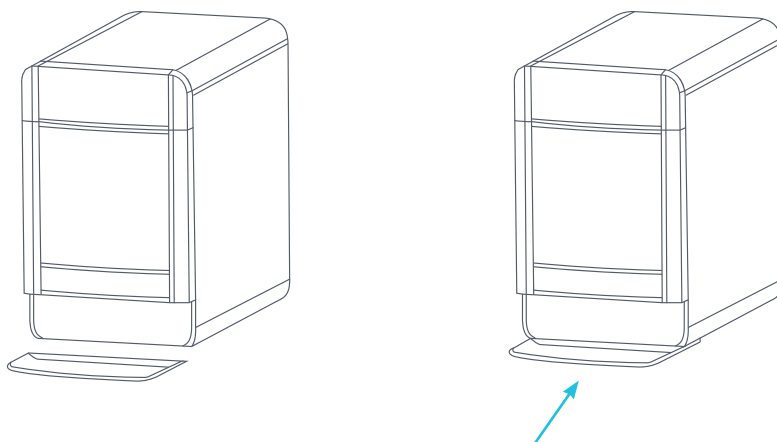

Installation

Installation (Under the Sink)

Installing the Metal Adapter with Valve

1. Turn off the current cold water supply that is the source of water to your sink.

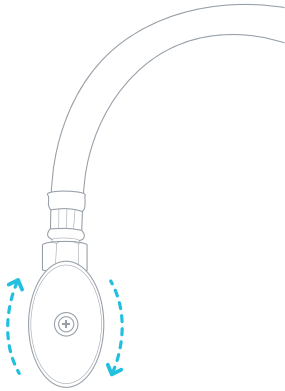

2. Disconnect the current cold water supply line under your sink.

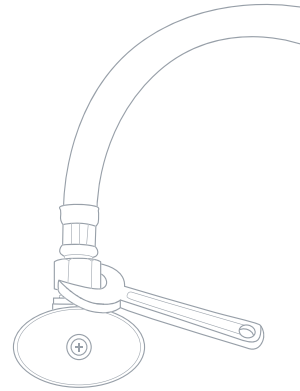

3. Connect the Metal Adapter with Valve between the cold water supply line and cold water valve.

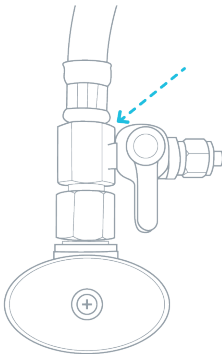

Installation (Under the Sink)

Installing the Metal Adapter with Valve

4. Remove the nut from the Metal Adapter with Valve and insert the PE Tubing through the nut. Slide the PE Tubing onto the protruding part of the Adapter where the nut was located until it reaches the threading.

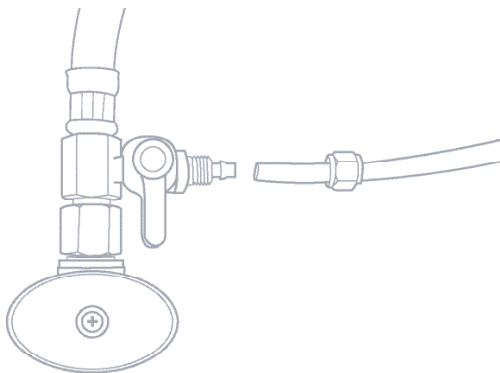

5. Screw the nut tightly into place to keep the PE Tubing securely connected to the Metal Adapter with Valve. Make sure the Valve is in the off position (perpendicular to the PE Tubing).

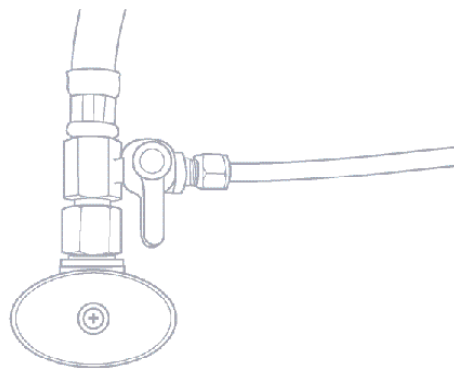

Installation (Refrigerator Water Line)

Installing the Three Way Plastic Adapter

1. Turn off the current cold water supply that is the source of water to your refrigerator line.

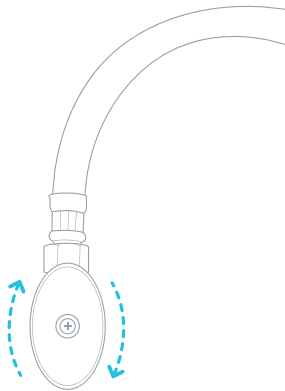

2. Cut the current $\frac{3}{8}$ " Tubing that is connected to the back of your refrigerator or ice maker near the end of it that is currently inserted into the refrigerator.

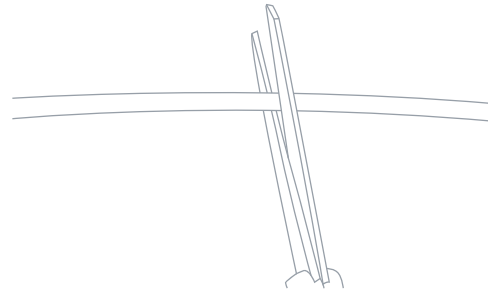

3. Insert each cut end of the existing $\frac{3}{8}$ " Tubing into one of the holes of the Three Way Plastic Adapter.

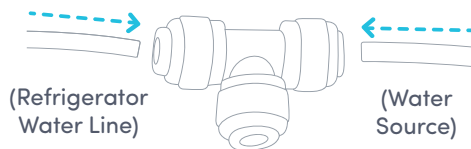

4. Insert one end of the PE Tubing that is supplied with the water cooler into the third opening of the Three Way Plastic Adapter.

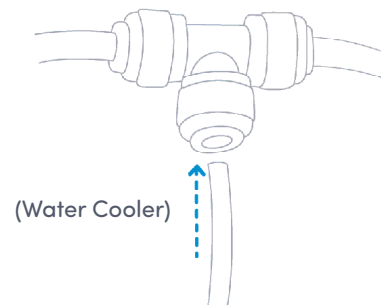

Finishing the Ice Maker Installation

1. Cut a small portion of this open ended PE tubing and connect the included pressure regulator in between the 2 pieces of PE tubing. The arrow on the pressure regulator should be pointing in the direction of the unit.

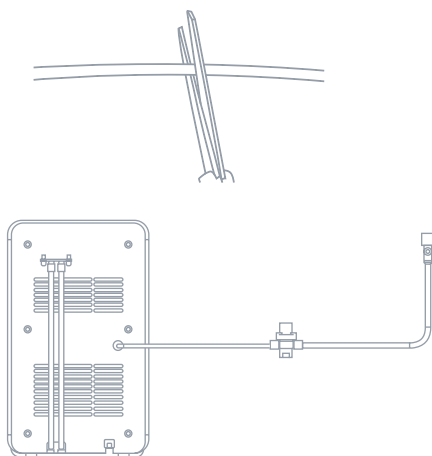

2. Remove the blue clip from the water inlet located on the back of the unit. Push the open end of the PE Tubing into the water inlet. Make sure the PE Tubing is tight and secure.

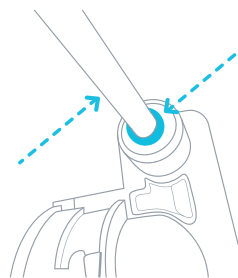

3. Turn the valve for the water source back on (the on position is parallel to the PE Tubing).

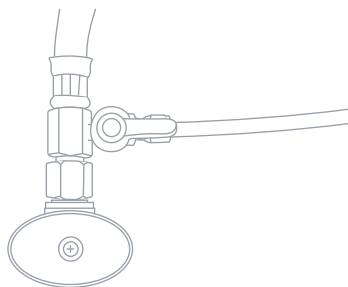

Finishing the Ice Maker Installation

4. If the water pressure exceeds the maximum allowable water inlet pressure or the inlet water intake splashes, press on the water pressure regulator.

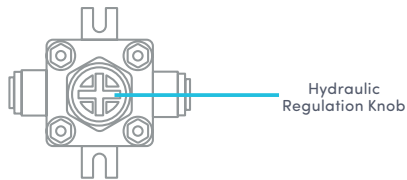

5. By adjusting the knob on the pressure regulator, the water pressure entering the ice maker is adjusted. Turn it clockwise to increase water pressure and turn it counterclockwise to reduce the water pressure.

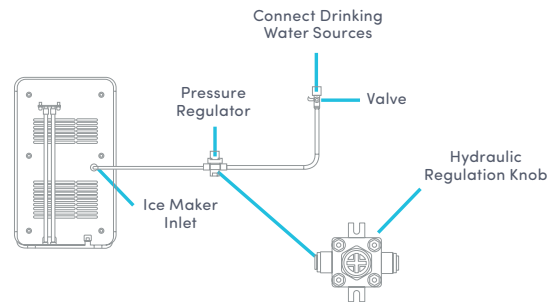

Making Ice

1. Press  the button and the  indicator will illuminate.

2. The water tank will begin to fill with filtered water up to the “MAX FULL LINE”.

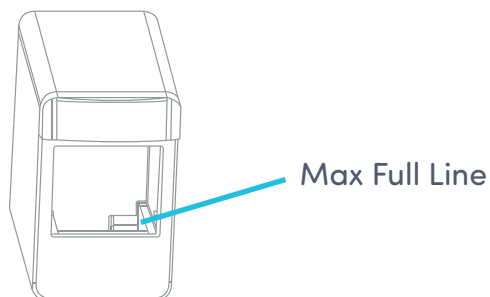



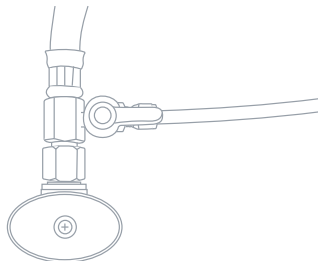

3. The  indicator will illuminate when there is no more water in the water tank.

4. Press  the to turn off the unit.



5. Ensure that the water line is turned on.



Making Ice

6. Press the  button again and the  indicator will turn off and the  indicator will illuminate.
7. When the ice drawer is full, the  will turn on and the machine will stop making ice until some ice is removed from the drawer.
8. To manually stop making ice, Press the  button for 3 seconds to stop making ice and turn off the unit.

Nightlight

1. While the unit is powered on, press the  to turn on the interior night light.
2. Press the  again to turn off the interior night light.

Cleaning

Maintenance

- It is recommended to clean your ice maker once a week in order to keep the ice cubes fresh.
- Always clean up the items and environment around the ice maker and keep the space ventilated.
- The cooling vents can be brushed up and down with a soft brush or a vacuum cleaner with a brush to maintain ventilation and heat dissipation, so as not to affect the cooling efficiency.
- The outside of the machine can be cleaned by scrubbing with a soft cloth, diluted detergent and warm water
- Do not let water flow into the inside of the machine or on the electrical components when cleaning the outside of the ice maker. Please wipe water stains on the outside of the ice maker to avoid electric shock.

Cleaning

When using the ice maker for the first time, or if the ice maker has not been cleaned for a long time, it is recommended to clean it before making ice. It is recommended to change the water every 24 hours to keep the water clean. To keep the ice cubes fresh, it is recommended to clean your ice maker once a week.

1. Before starting the cleaning process, please check the drain tube on the back of the machine to ensure that it is connected to the drain plug.

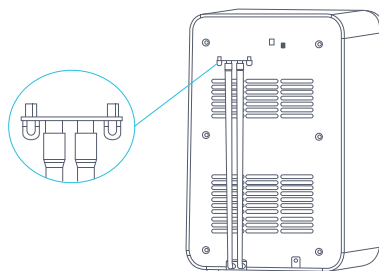

2. Remove the ice storage drawer. (see page 6)
3. Add drinking water to the inner tank of the ice maker until the “MAX FULL LINE” water level line.

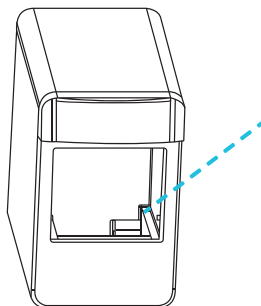

Cleaning

Note: Do not use cleaning agents or solutions that are harmful to people.

4. While the unit is plugged in and turned on, press the cleaning button for 3 seconds. The cleaning indicator will light up and the water will begin circulating throughout the machine. This cleaning process will last for 5 minutes. Once completed, the cleaning indicator will turn off.



5. You may also end the cleaning process sooner by pressing the cleaning button again.

6. After the cleaning process has stopped, disconnect the end of the drain tube that is connected onto the back of the device and remove it from its plug.

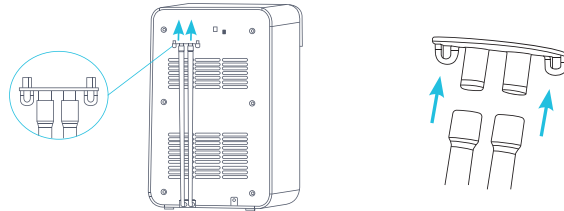

7. Place this open end of the drain tube into a container, bucket, or sink that is located at a level lower than the ice maker and allow the water from the ice maker to drain completely.

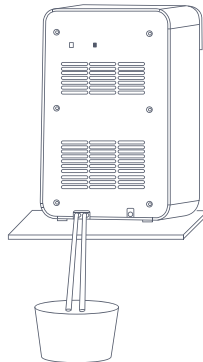

Cleaning

8. Once the water inside the ice maker is completely drained, re-insert the drain tube into the drain tube plug.
9. Repeat steps 3-7 for more thorough cleaning.
10. After cleaning, reconnect the drain tube with its plug to the back of the machine.
11. Add drinkable water to the inner tank to begin making ice.

Troubleshooting

Troubleshooting

The following simple issues can be handled by the user. Please call the after-sale service department if the issues are not settled.

Fault	Potential Cause	Solution
"Add water" Indicator light on	Lack of water	Stop ice making or cleaning, add water to the water tank of the ice maker, and then start ice making
"ice full" indicator light on	The ice storage drawer is full of ice No ice	Remove the ice from the drawer Ice full infrared sensor is affected by objects or dust
"Add water" Indicator light on	Lack of water	Stop ice making or cleaning, add water to the water tank of the ice maker, and then start ice making
Making ice slowly or no ice is made	Mains voltage is too low or socket it too loose The ambient temperature or the water temperature is too high Poor ventilation Excessive accumulation of minerals	Check power supply and outlet, replace It is recommended that the working environment temperature of the ice maker is below 32°C (89°F), and the temperature of adding water is 7-32°C (45-89°). Check that the ice maker vents are not blocked, and clear the vents or surrounding items to maintain a ventilated space Start self-cleaning function

Troubleshooting

The following simple issues can be handled by the user. Please call the after-sale service department if the issues are not settled.

Fault	Potential Cause	Solution
Leak of water	Refrigerant leakage Drain plug not installed in place The drip tray is full of water	Need professional maintenance Install the drain pipe into the drain plug Clean up the water in the drip tray in time

Warranty

Warranty

Models included are:

A1TLWATERCOOLER, A2TLWATERCOOLER, A3BLOZONETRCLR, A3F, A3F-SC, A4BLWTRCLR, A4F, A1BOTTLELESS, A5BOTTLELESS, A5BLK, A6BLWTRCLRWH, A6BLWTRCLRBLK, A7BOTTLELESS, A7BOTTLELESSBLK, A8CBOTTLELESSWHT, A8CBOTTLELESSBLK, A9CTELECTRICSS, A9ELECTRICBLK, A9ELECTRICWHT, A10-TL, A11-CTTL, A12-CTPOU, A13, A14, A15, A1CTWTRCLRBLK, A1CTWTRCLRWH, A3BLK, A4F, A5BLK, A6SC-WHT, A6SC-BLK, A10BLK, A11BLK, A12BLK, A13BLK, A14BLK, A13CT, A13-S, B8WHT, B8BLK, A9, A23, A23BLK, A24, A25, A25BLK, A-ICE, A -ICE2

Products listed above are covered by the terms of this Limited Warranty. For purposes of this Limited Warranty, the term "product" means any water cooler bottled or bottleless manufactured for Avalon. Avalon warrants that it will, at Avalon's option, replace or repair the Purchaser's Avalon product sold in the U.S. or Canada by an authorized retailer if that product is defective due to faulty workmanship or materials, subject to the limitations described in this Limited Warranty. Avalon undertakes no responsibility for the quality of the goods except as otherwise provided in this warranty. There are no warranties that extend beyond the description on the face hereof. This Limited Warranty is valid only in connection with the original purchase of new products from authorized retailers and extends from the original purchase date of the original product purchased. This warranty extends only to the original purchaser of the product and lasts for one (1) year from the date of the original purchase or until the original purchaser of the product sells or transfers the product, whichever first occurs. An "original purchaser," for the purposes of this Limited Warranty, is an individual or entity who purchases the product directly from Avalon or an authorized retailer of Avalon with the intent to use the product for personal consumer use and commercial or industrial use and not with the intent to resell the product. An "authorized retailer," for purposes of this Limited Warranty, is an individual or entity authorized by Avalon to sell the product directly to original purchasers. An individual or entity that purchases the product from whatever source with the intent to resell the product is an unauthorized reseller ("unauthorized reseller"). For the purpose of this Limited Warranty a "Third Party" would be considered any plumber, maintenance company, or individual hired by the Purchaser.

This Limited Warranty does not apply to used, refurbished, renewed, floor model or "demo" products, or to products sold by unauthorized resellers, including without limitation, unauthorized resellers on third party websites, including, without limitation, Craigslist, eBay, Amazon, etc. Unauthorized resellers are not "original purchasers" for the purpose of this Limited Warranty. If the purchaser is not the original purchaser of this product, the purchaser takes the product "AS IS," "with all faults" and without warranty. Avalon reserves the right to require a valid serial number located on your product to submit a valid claim under this Limited Warranty. Products where the serial number has been removed or evidence showing the removal or attempted removal of the serial number label will not be eligible to make a claim under this Limited Warranty. IF THE PURCHASE OF THIS PRODUCT WAS NOT DIRECTLY FROM AVALON, PROOF OF PURCHASE WILL BE REQUIRED TO DEMONSTRATE THAT PURCHASER IS THE ORIGINAL PURCHASER AND THE PRODUCT WAS PURCHASED FROM AN AUTHORIZED RETAILER, AND ELIGIBLE TO MAKE A VALID CLAIM UNDER THIS LIMITED WARRANTY.

Your purchase date is established from the date of your sales receipt. Avalon may require the purchaser to provide proof of the quality and condition of the water cooler if the purchaser makes a claim under this Limited Warranty. Avalon reserves the right to invalidate this Limited Warranty if the water cooler is determined, in Avalon's reasonable discretion, to be inadequate or if the water cooler is found to be in an unsanitary condition. This warranty does not apply if the product was damaged or failed because of accident, improper handling or operation, relocation, abuse, misuse, unauthorized repairs made or attempted, or improper installation or maintenance. Under this Limited Warranty, products are required to be plugged directly into a grounded wall outlet. Plugging a product into an extension cord or surge protector will be considered misuse and will void this Limited Warranty. If damage to the product has occurred during shipping, the damage must be reported to Avalon within the first 30 days from the original purchase date to be eligible to make a claim under the Limited Warranty. Shipping damage reported to Avalon outside of the first 30 days from the original purchase date will not be eligible for a valid claim under this Limited Warranty. This warranty does not cover shipping costs for the return of products to Avalon for repair or replacement.

To submit a valid claim under this Limited Warranty, troubleshooting the product with an Avalon Customer Success Expert is required. If troubleshooting the product is refused by the Purchaser, Avalon reserves the right to deny the Limited Warranty Claim. In the event a part is necessary to correct the problem with a Product, Avalon will provide the part at no cost to the original purchaser under this Limited Warranty. Replacing parts or attempting to correct an issue with the Product is required prior to submitting a claim for a replacement product under this Limited Warranty. Instructions for troubleshooting a Product or replacing a part will be provided by Avalon. Troubleshooting, repairs, part replacement, installation, and proper maintenance are the responsibility of the Purchaser. Instructions for proper installation and maintenance will be provided in the user manual.

Installation, maintenance, or repairs of the Product is the responsibility of the Purchaser. The Purchaser reserves the right to use a Third Party for installation, maintenance, and repair at their own risk. Avalon is not responsible for any additional cost incurred for installation, maintenance, or repair of the Product including but not limited to additional material needed for installation or the cost of a Third Party. Damage or failure of the Product due to improper installation, maintenance, or repair caused by a Third Party or the Purchaser is not the responsibility of Avalon and will not be covered under this Limited Warranty. Instructions for proper installation and maintenance will be provided in the user manual.

ANY AND ALL WARRANTIES, EXPRESSED OR IMPLIED (INCLUDING, WITHOUT LIMITATION, ANY IMPLIED WARRANTY OF MERCHANTABILITY), LAST ONE YEAR FROM THE DATE OF ORIGINAL PURCHASE OR UNTIL THE ORIGINAL PURCHASER OF THE PRODUCT SELLS OR TRANSFERS THE PRODUCT, WHICHEVER FIRST OCCURS. IN NO EVENT SHALL AVALON'S LIABILITY UNDER ANY EXPRESS OR IMPLIED WARRANTY INCLUDE (I) INCIDENTAL OR CONSEQUENTIAL DAMAGES FROM ANY CAUSE WHATSOEVER, INCLUDING BUT NOT LIMITED TO ELECTRICAL OR WATER DAMAGE, OR (II) REPLACEMENT OR REPAIR OF ANY HOUSE FUSES, CIRCUIT BREAKERS OR RECEPTACLES. NOTWITHSTANDING ANYTHING TO THE CONTRARY, IN NO EVENT SHALL AVALON'S LIABILITY UNDER ANY EXPRESS OR IMPLIED WARRANTY EXCEED THE PURCHASE PRICE OF THE PRODUCT AND ANY SUCH LIABILITY SHALL TERMINATE UPON THE EXPIRATION OF THE WARRANTY PERIOD.

Except as otherwise provided, Avalon will not charge Original Purchaser to repair or replace the purchaser's Product if it is deemed defective during the length of this Limited Warranty, but any transportation costs associated with repairs or replacements are Purchaser's responsibility. No new warranty is provided with a replacement product. The warranty for the replacement product runs from the date of the original purchase of the original product. In the event that repair is necessary, such repair will be at no charge to the Purchaser except for transportation costs associated with such repair or replacement of a product in compliance with the terms of this Limited Warranty.

In the event, a warranty claim is filed and a warranty replacement is deemed necessary, the purchaser will be required to surrender the original product to Avalon at the time of replacement.

Some states and provinces do not allow limitations on how long an implied warranty lasts or the exclusion or limitation of incidental or consequential damages, so these exclusions or limitations may not apply to you. This warranty gives you specific legal rights. You may also have other rights which vary from state to state and province to province.

